

Linear Trunking System

# PIRATE

# CONTENT

## Applications

- 002-003 Court
- 004-005 Industry
- 006-007 Car Washing

## Product detail

- 008 Explosion Drawing
- 010-011 LED module
- 012-015 Trunking
- 016-019 Accessory

PIRATE is suitable for Basketball court, Tennis court, Ice hockey rink, Handball court, car washing room, industry and other places where have special requirements for the protection of luminaires

## Applications

### Industry

#### Court - Switzerland

With a run of three courts, the aim was to achieve a uniform light pattern across each court, whilst utilising the existing mounting poles. With club hours extending through all seasons the need for illuminated courts is evergrowing, and so running and maintenance costs are also a focus

In this case, the luminaire is 8.0 meters away from the ground, using a 60W 90 degree lens.

### Project Request



Quantity	Code	Description
400	PIRATE-L1450-7x2.5	PIRATE 1438mm trunking 7 x 2.5 mm <sup>2</sup> ,white
200	PIRATE-15-AL-01	1438mm Aluminium
200	PIRATE-L1450-5000K-60AD	PIRATE LED Module 90°,32-60W, 9,000 lm, 5,000 K, non-dimmable,White
300	PIRATE-SMK	Steel suspension

## Applications

### Industry

#### Warehouse - Switzerland

PIRATE grants users high performance lighting. Sets of ten 60W luminaires were installed in order to obtain 90,000 lumens per set of units and thus had an illumination akin to sunlight. Furthermore, the luminaires with microwave sensors installed in needed areas can maximize energy saving, reducing unnecessary lighting waste.

In this case, the luminaire is 8.0 meters away from the ground, using a 60W 90 degree lens.

### Project Request



Quantity	Code	Description
200	PIRATE-L2900-7x2.5	PIRATE 2876mm trunking 7 x 2.5 mm <sup>2</sup> ,white
156	PIRATE-L1450-5000K-60AD	PIRATE LED Module 35°,32-60W, 9,000 lm, 5,000 K, non-dimmable,White
300	PIRATE-SMK	Steel suspension

## Applications

### Car washing

#### Car Washing Room-Germany

Over time, this car washing room with old light tubes was deficient in light. Moreover, the longevity of the old lighting fixtures were cut because of prolonged exposure to humid condition. Customer used LEDesta PIRATE to replace old fixtures, giving the car washing room a brighter lighting. Other than that, with waterproof feature, this luminaire is serviceable for more than 5 years.

### Project Request



Quantity	Code	Description
200	PIRATE-L2900-7x2.5	PIRATE 2876mm trunking 7 x 2.5 mm <sup>2</sup> ,white
156	PIRATE-L1450-5000K-60AD	PIRATE LED Module 35°,32-60W, 9,000 lm, 5,000 K, non-dimmable,White
244	PIRATE-15-AL-01	ALuminum Blind COVER
300	PIRATE-SMK	Steel suspension

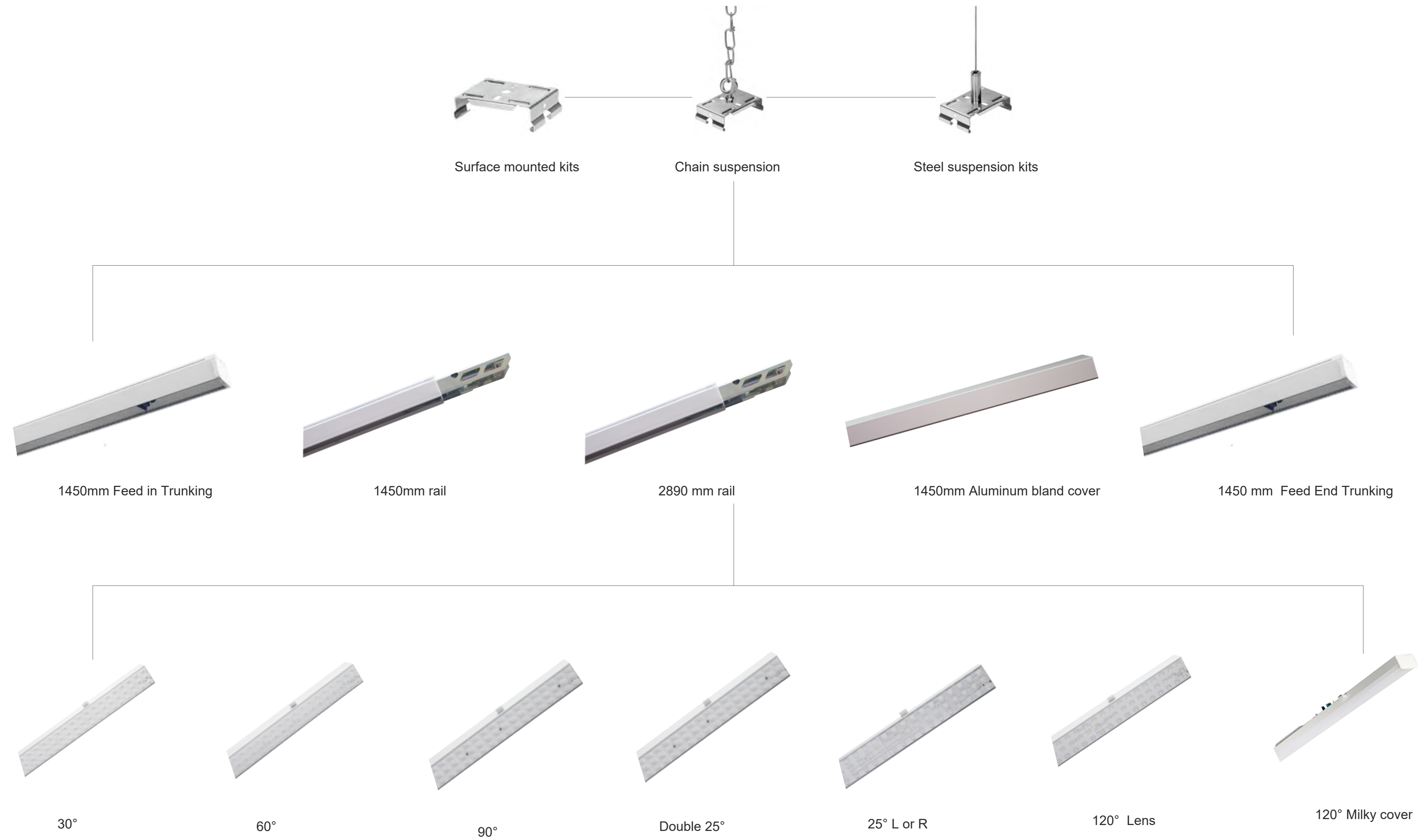

# Product detail

# LED Modules

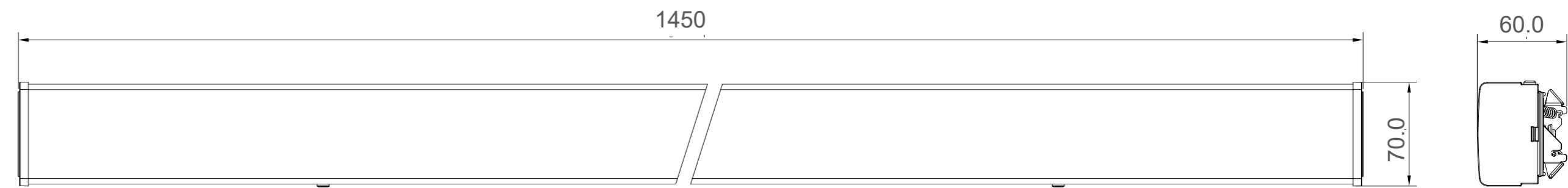
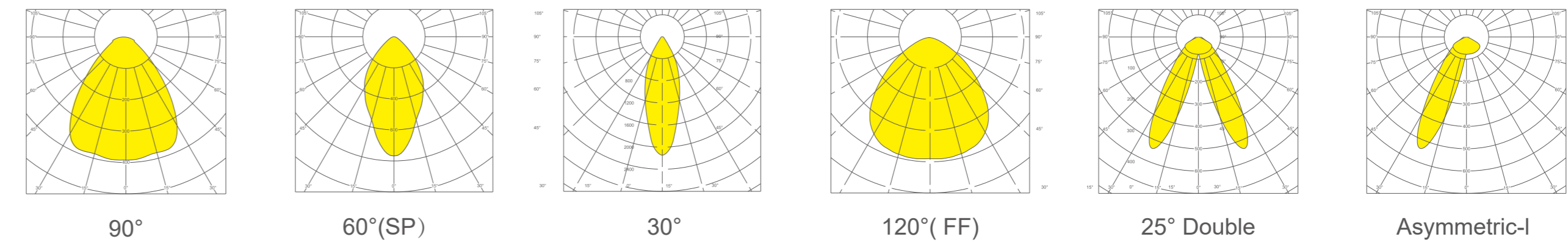

## Datasheet

TYPE	POWER (W)	LUMEN (LM)	EFFICACY (LM/W)	CCT (K)	CRI (RA)	Driver (Brand)	Voltage (V)	Function	Dimensions (mm)	WEIGHT (kg)
PIRATE-L1450-3000K-60AD-S	60W adjust 50W 42W 32W by switch	Max 8000	150	3000K	>80	Vossloh-Schwabe or OSRAM	AC 220-240V	Non-Dimmable	1438 x 65 x 27	1.65
PIRATE-L1450-4000K-60AD-S	60W adjust 50W 42W 32W by switch	Max 9000	160	4000K	>80	Vossloh-Schwabe or OSRAM	AC 220-240V	Non-Dimmable	1438 x 65 x 27	1.65
PIRATE-L1450-5000K-60AD-S	60W adjust 50W 42W 32W by switch	Max 9000	160	5000K	>80	Vossloh-Schwabe or OSRAM	AC 220-240V	Non-Dimmable	1438 x 65 x 27	1.65
PIRATE-L1450-6000K-60AD-S	60W adjust 50W 42W 32W by switch	Max 9000	160	6000K	>80	Vossloh-Schwabe or OSRAM	AC 220-240V	Non-Dimmable	1438 x 65 x 27	1.65
PIRATE-L1450-3000K-68AD-P	68W-60W-54W-48W-38W-32W-25W-20W by Switch	Max 9800	150	3000K	>80	Philips	AC 220-240V	Non-Dimmable	1438 x 65 x 27	1.9
PIRATE-L1450-4000K-68AD-P	68W-60W-54W-48W-38W-32W-25W-20W by Switch	Max 10,200	160	4000K	>80	Philips	AC 220-240V	Non-Dimmable	1438 x 65 x 27	1.9
PIRATE-L1450-5000K-68AD-P	68W-60W-54W-48W-38W-32W-25W-20W by Switch	Max 10,200	160	5000K	>80	Philips	AC 220-240V	Non-Dimmable	1438 x 65 x 27	1.9
PIRATE-L1450-6000K-68AD-P	68W-60W-54W-48W-38W-32W-25W-20W by Switch	Max 10,200	160	6000K	>80	Philips	AC 220-240V	Non-Dimmable	1438 x 65 x 27	1.9
PIRATE-L1450-3000K-72AD-B	72W adjust 68W 64W 60W 58W 56W 54W 50W 48W 45W by switch	Max 8800	140	3000K	>80	BOKE	AC 220-240V	1-10V	1438 x 65 x 27	2.1
PIRATE-L1450-4000K-72AD-B	72W adjust 68W 64W 60W 58W 56W 54W 50W 48W 45W by switch	Max 9600	150	4000K	>80	BOKE	AC 220-240V	1-10V	1438 x 65 x 27	2.1
PIRATE-L1450-5000K-72AD-B	72W adjust 68W 64W 60W 58W 56W 54W 50W 48W 45W by switch	Max 9600	150	5000K	>80	BOKE	AC 220-240V	1-10V	1438 x 65 x 27	2.1
PIRATE-L1450-6000K-72AD-B	72W adjust 68W 64W 60W 58W 56W 54W 50W 48W 45W by switch	Max 9600	150	6000K	>80	BOKE	AC 220-240V	1-10V	1438 x 65 x 27	2.1
PIRATE-L1450-3000K-68AD-P/T	16W to 68W by resistor	Max 9800	150	3000K	>80	Philips or Tridonic	AC 220-240V	DALI	1438 x 65 x 27	2.1
PIRATE-L1450-4000K-68AD-P/T	16W to 68W by resistor	Max 10,200	160	4000K	>80	Philips or Tridonic	AC 220-240V	DALI	1438 x 65 x 27	2.1
PIRATE-L1450-5000K-68AD-P/T	16W to 68W by resistor	Max 10,200	160	5000K	>80	Philips or Tridonic	AC 220-240V	DALI	1438 x 65 x 27	2.1
PIRATE-L1450-6000K-68AD-P/T	16W to 68W by resistor	Max 10,200	160	6000K	>80	Philips or Tridonic	AC 220-240V	DALI	1438 x 65 x 27	2.1

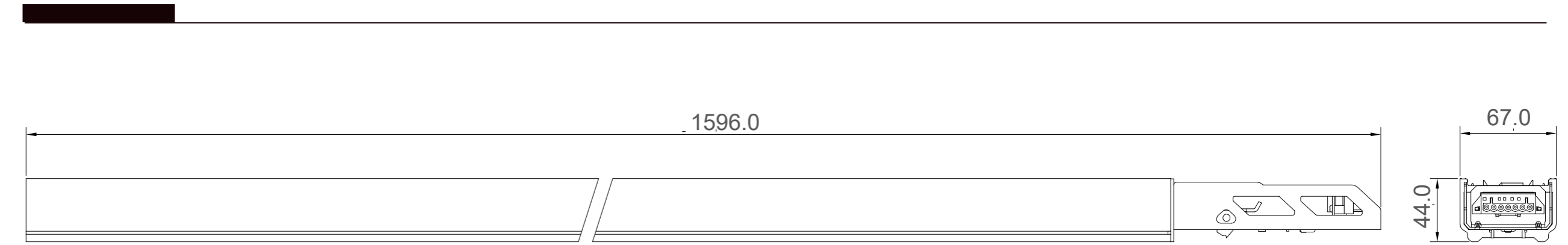
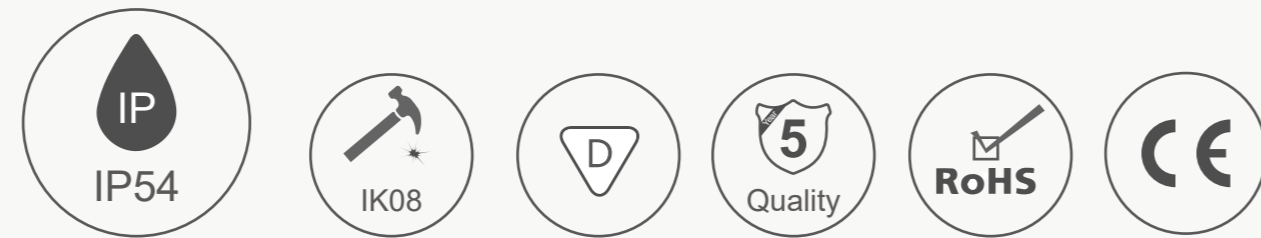

Datasheet

White:

TYPE	WIRES (m)	Dimensions (mm)	WEIGHT (kg)
PIRATE-L600-5x2.5	5 x2.5 mm <sup>2</sup>	590x 65 x 65	0.85
PIRATE-L600-7x2.5	7 x2.5 mm <sup>2</sup>	590x 65 x 65	0.95
PIRATE-L1450-5x2.5	5 x2.5 mm <sup>2</sup>	1450x 65 x 65	1.59
PIRATE-L1450-7x2.5	7 x2.5 mm <sup>2</sup>	1450x 65 x 65	1.65
PIRATE-L1450-11x2.5	11 x2.5 mm <sup>2</sup>	1450x 65 x 65	1.95
PIRATE-L2900-5x2.5	5 x2.5 mm <sup>2</sup>	2890x 65 x 65	2.85
PIRATE-L2900-7x2.5	7 x2.5 mm <sup>2</sup>	2890x 65 x 65	2.98
PIRATE-L2900-11x2.5	11 x2.5 mm <sup>2</sup>	2890x 65 x 65	3.25

Black:

TYPE	WIRES (m)	Dimensions (mm)	WEIGHT (kg)
PIRATE-L600-5x2.5	5 x2.5 mm <sup>2</sup>	590x 65 x 65	0.85
PIRATE-L600-7x2.5	7 x2.5 mm <sup>2</sup>	590x 65 x 65	0.95
PIRATE-L1450-5x2.5	5 x2.5 mm <sup>2</sup>	1450x 65 x 65	1.59
PIRATE-L1450-7x2.5	7 x2.5 mm <sup>2</sup>	1450x 65 x 65	1.65
PIRATE-L1450-11x2.5	11 x2.5 mm <sup>2</sup>	1450x 65 x 65	1.95
PIRATE-L2900-5x2.5	5 x2.5 mm <sup>2</sup>	2890x 65 x 65	2.85
PIRATE-L2900-7x2.5	7 x2.5 mm <sup>2</sup>	2890x 65 x 65	2.98
PIRATE-L2900-11x2.5	11 x2.5 mm <sup>2</sup>	2890x 65 x 65	3.25

Installation

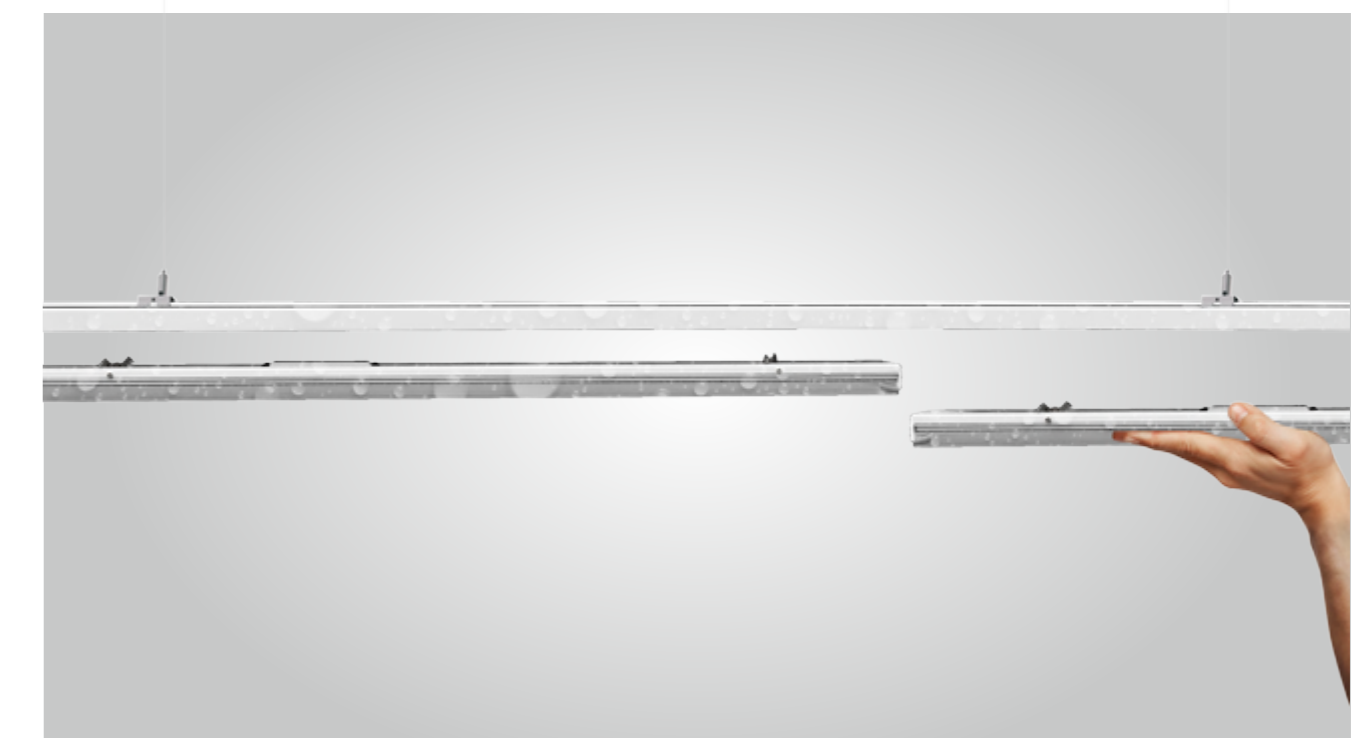
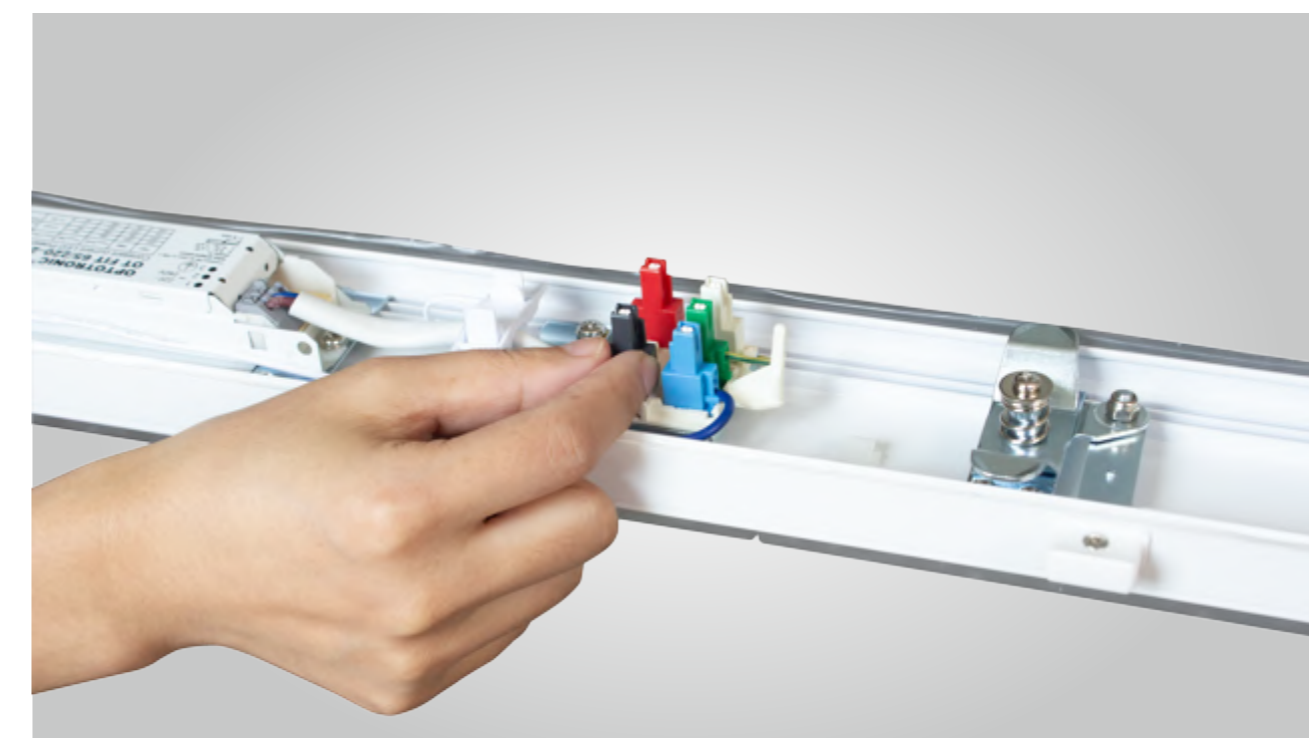
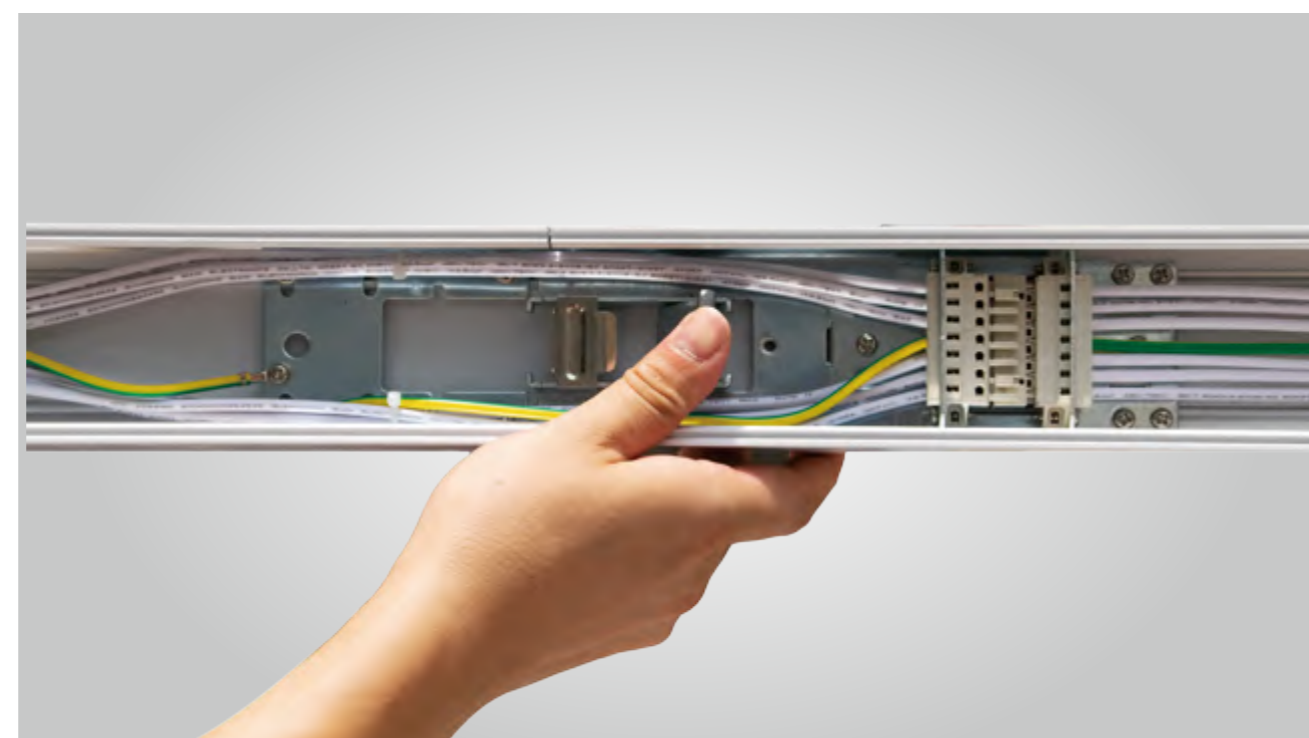



Product detail

Trunking

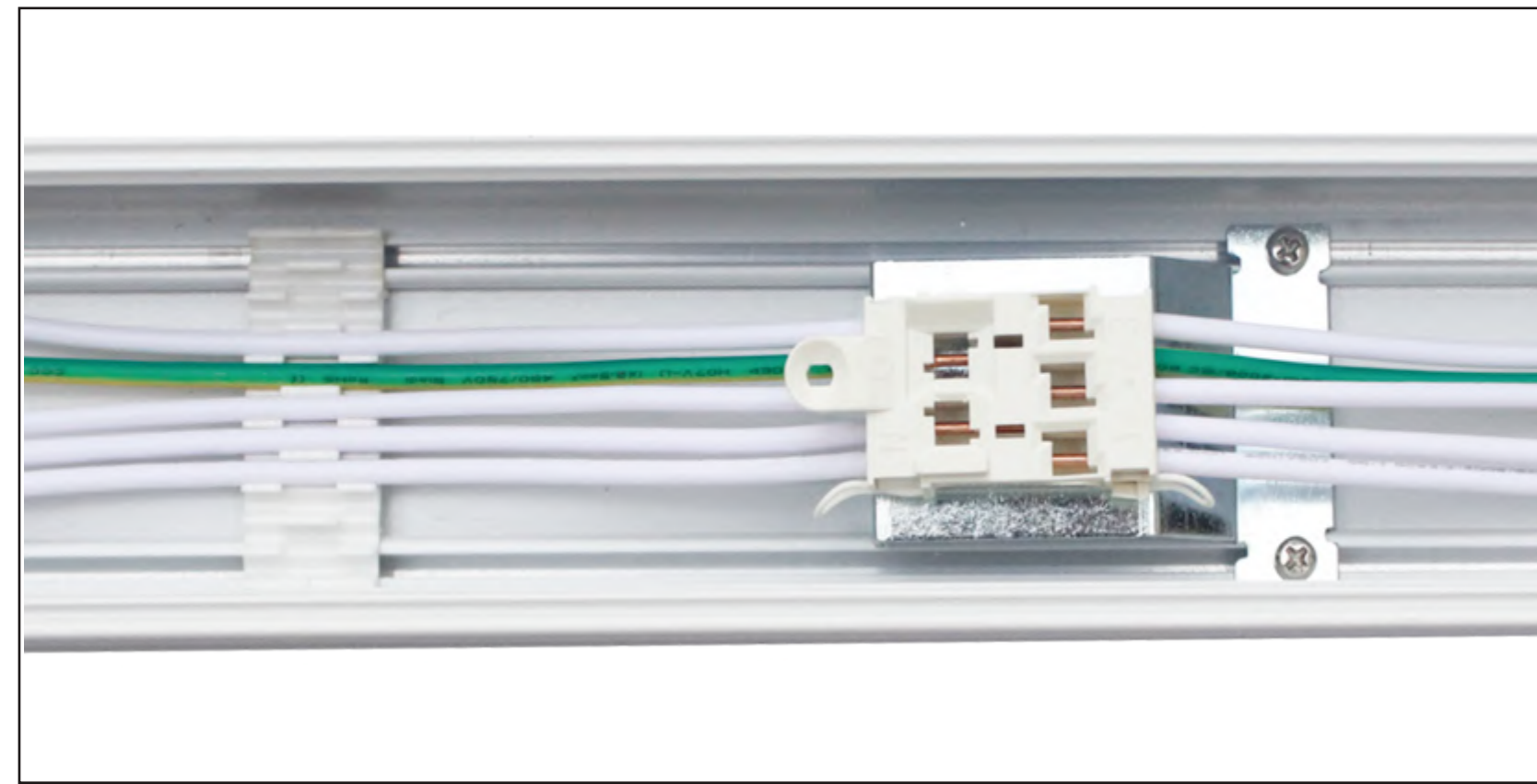

5-Pole

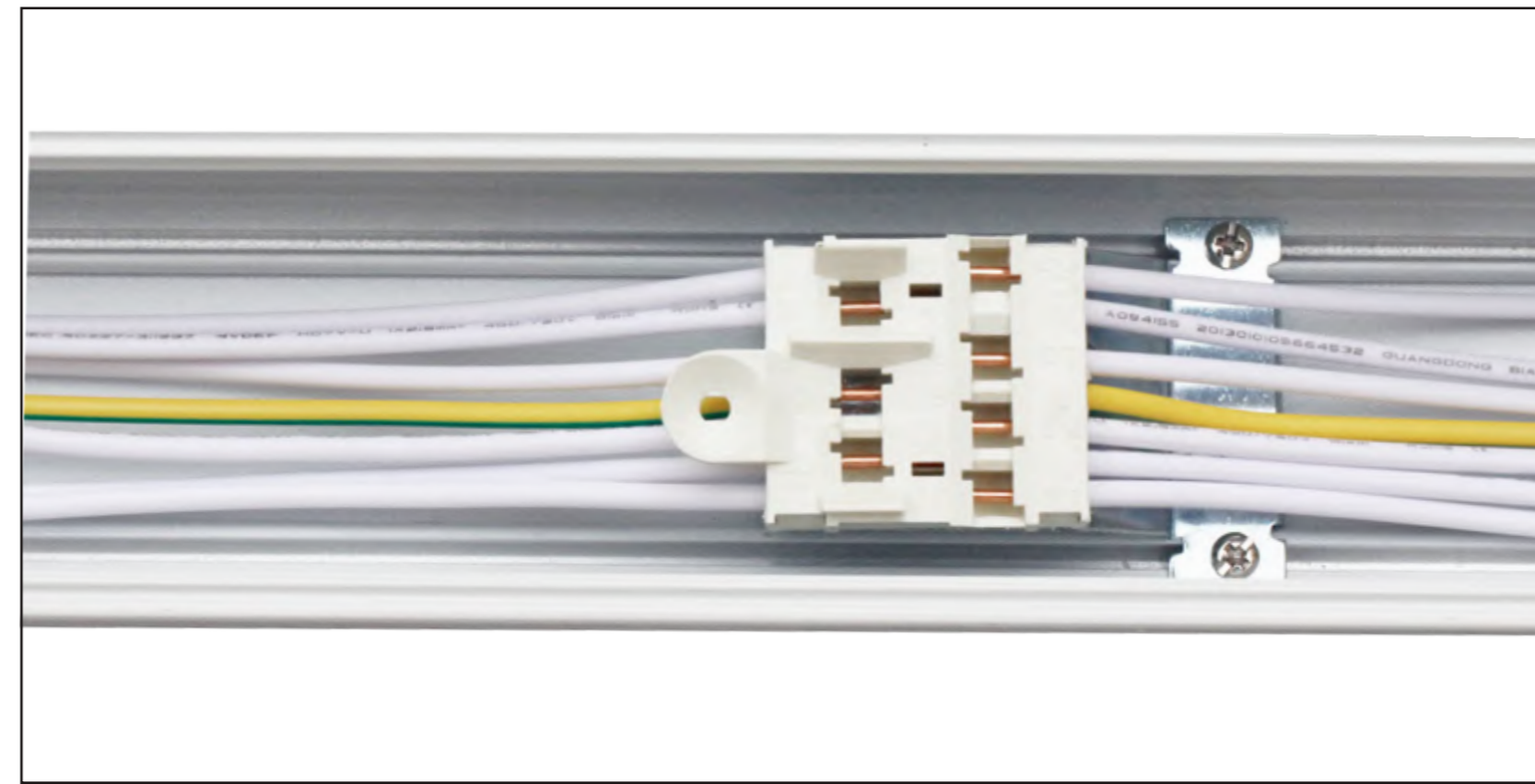

7-Pole

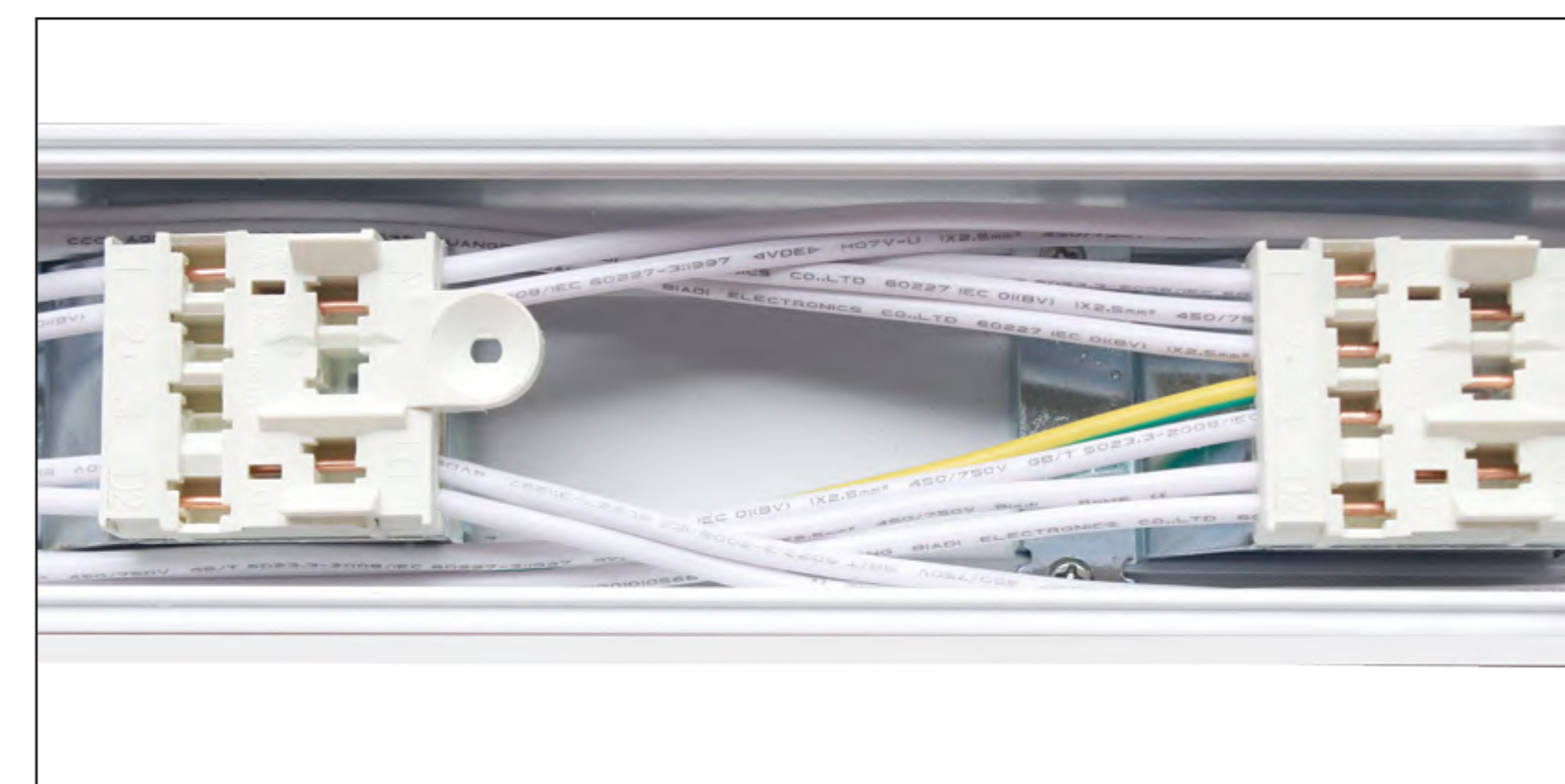

11-Pole

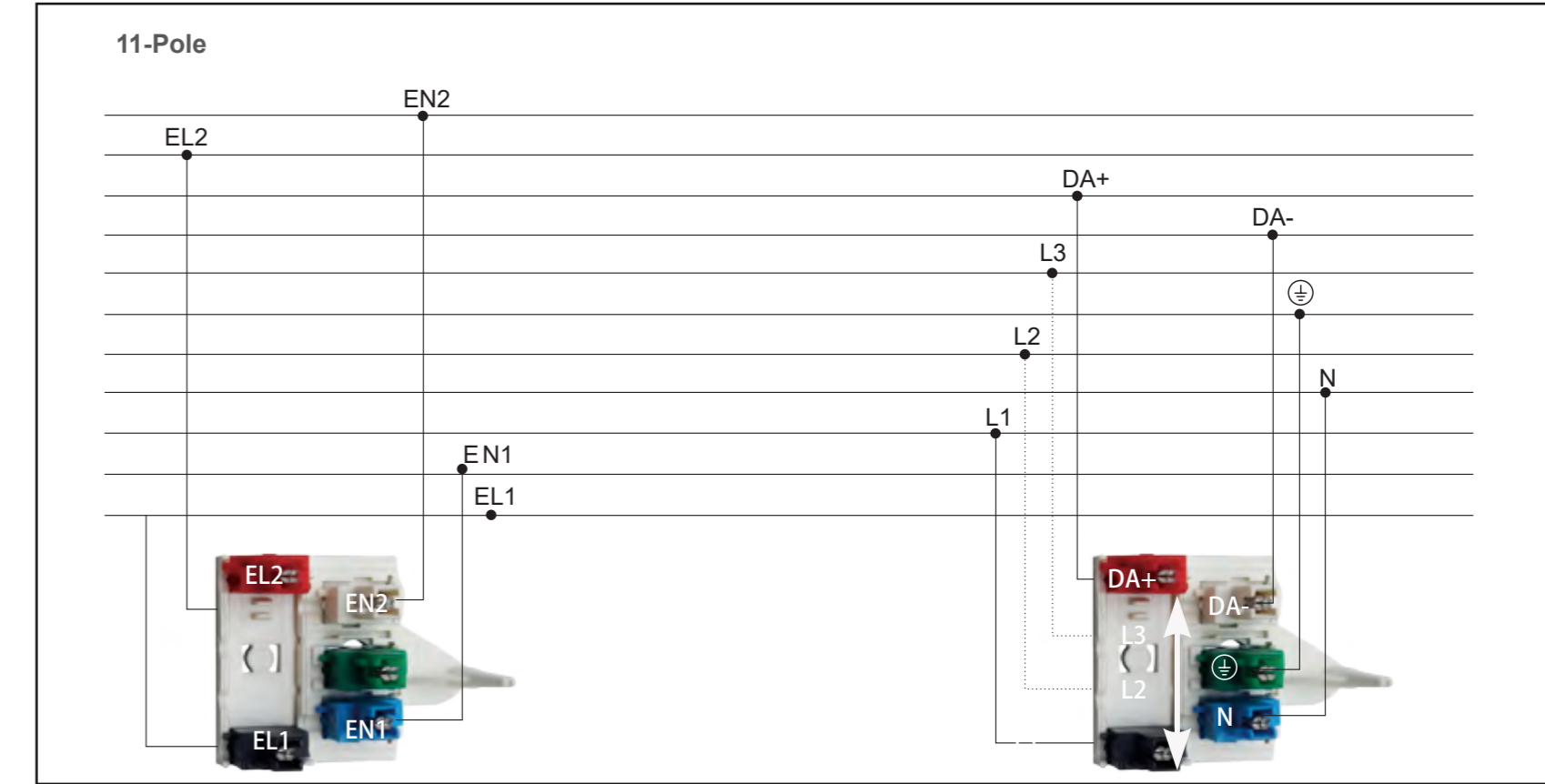
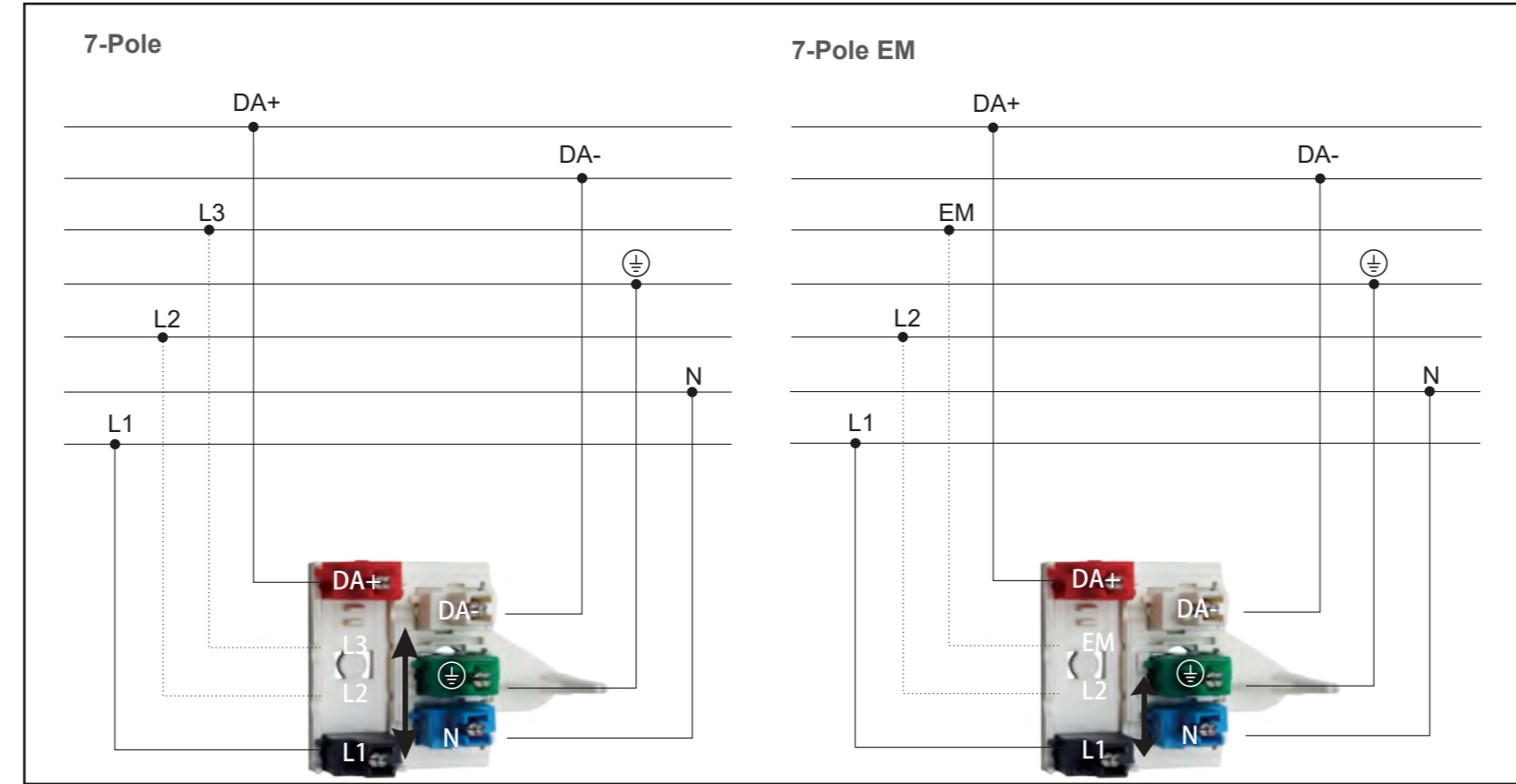
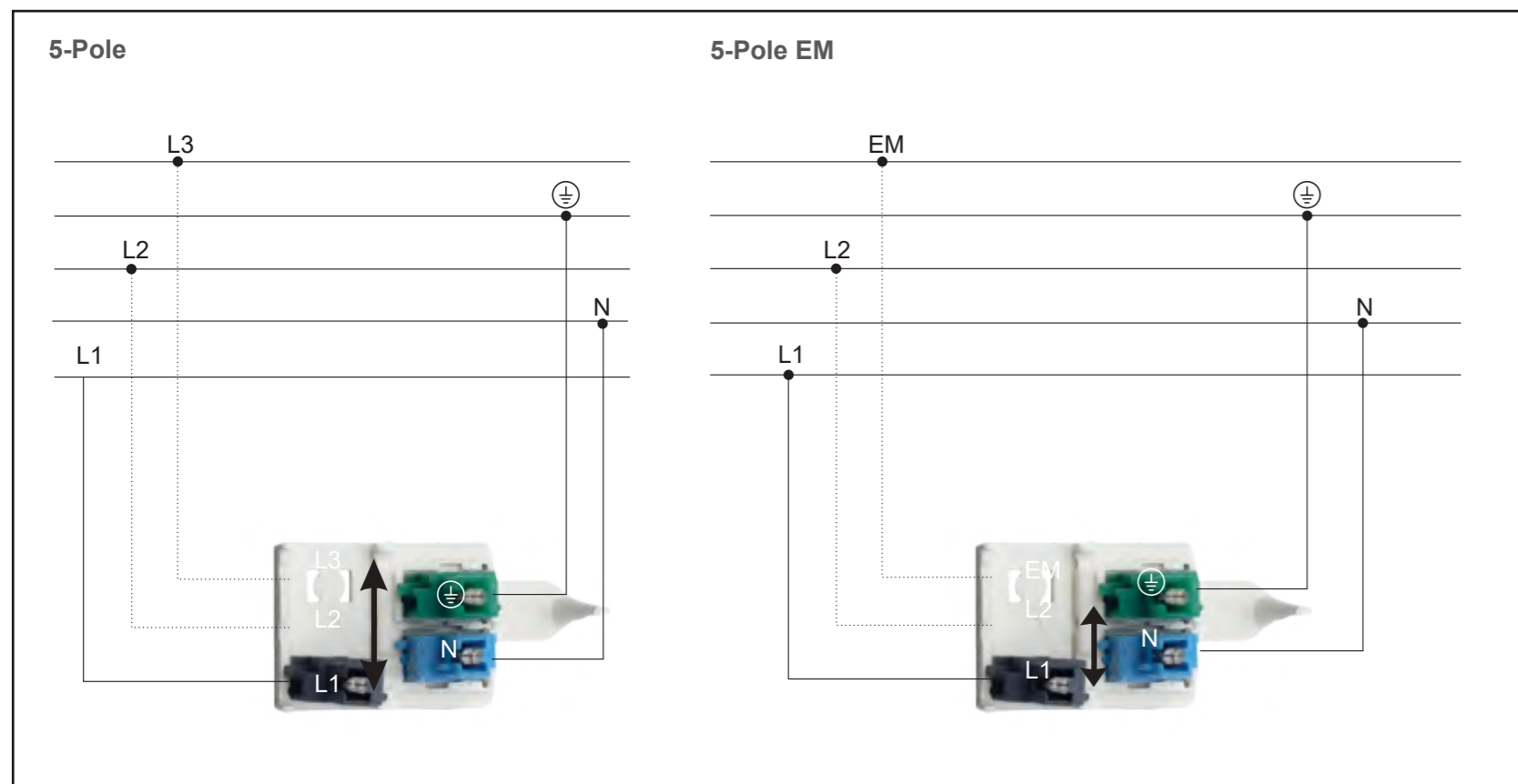

Tool-free installation



Connector for quick connection between Trunking rail and led module

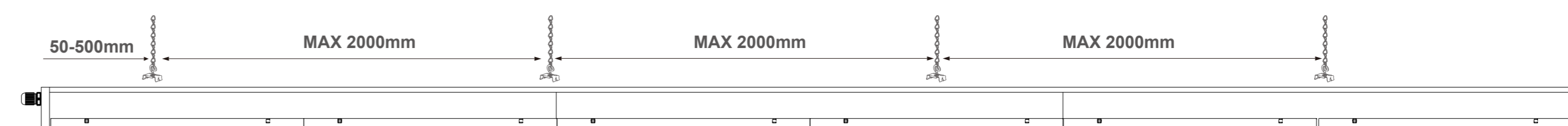

AC Input

Feed in Trunking

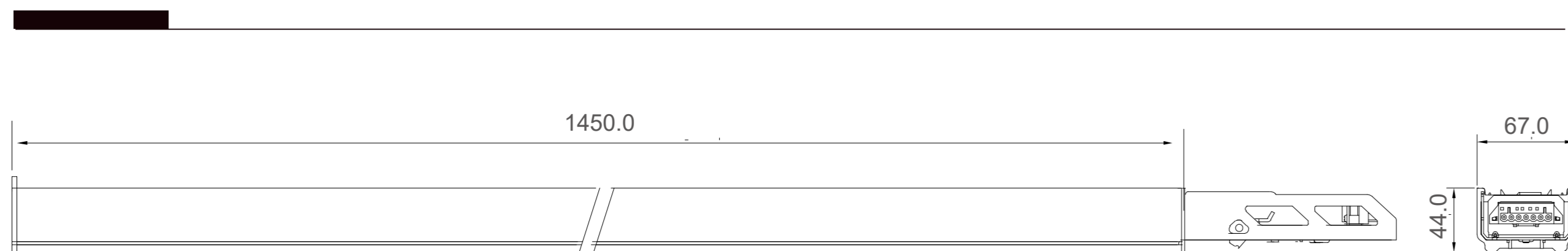

Datasheet

White:

TYPE	WIRES (m)	Dimensions (mm)	WEIGHT (kg)
PIRATE-L1450-5x2.5	5 x2.5 mm <sup>2</sup>	1450x 65 x 65	1.59
PIRATE-L1450-7x2.5	7 x2.5 mm <sup>2</sup>	1450x 65 x 65	1.65

Black:

TYPE	WIRES (m)	Dimensions (mm)	WEIGHT (kg)
PIRATE-L1450-5x2.5	5 x2.5 mm <sup>2</sup>	1450x 65 x 65	1.59
PIRATE-L1450-7x2.5	7 x2.5 mm <sup>2</sup>	1450x 65 x 65	1.65

Feed End Trunking

AC Input

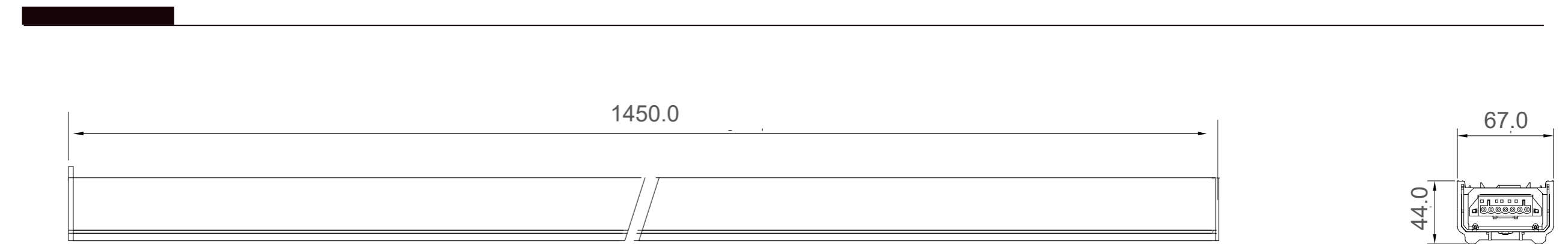

Datasheet

White:

TYPE	WIRES (m)	Dimensions (mm)	WEIGHT (kg)
PIRATE-L1450-5x2.5	5 x2.5 mm <sup>2</sup>	1450x 65 x 65	1.59
PIRATE-L1450-7x2.5	7 x2.5 mm <sup>2</sup>	1450x 65 x 65	1.65

Black:

TYPE	WIRES (m)	Dimensions (mm)	WEIGHT (kg)
PIRATE-L1450-5x2.5	5 x2.5 mm <sup>2</sup>	1450x 65 x 65	1.59
PIRATE-L1450-7x2.5	7 x2.5 mm <sup>2</sup>	1450x 65 x 65	1.65

Product detail

Sensor



Max. 8M



Hold Time  
5s~30min



Mounting Height  
15m Max.

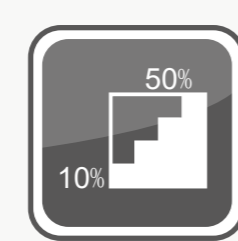

Automatic  
Dimming

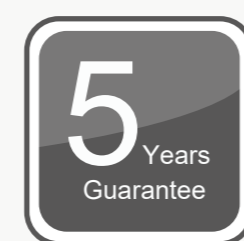

5  
Years  
Guarantee

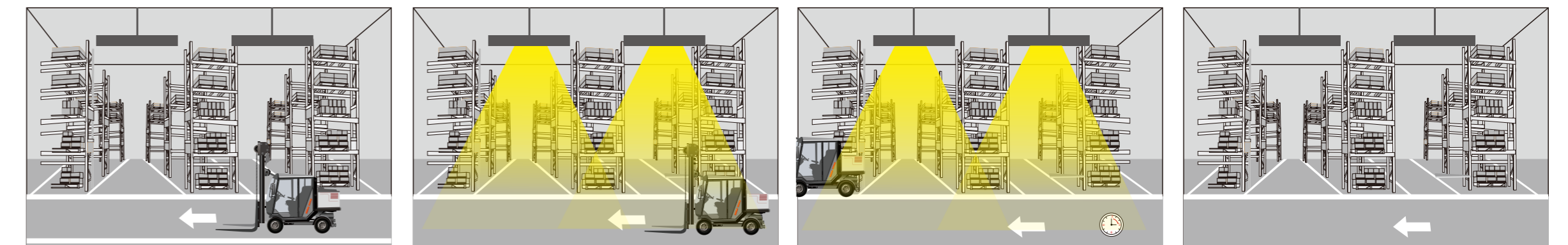

Type	Description	Length	Weight
SENSOR-00	1-10V Microwave Sensor suitable for ceiling heights from 3 to 15 m	1450mm	1.05kg
SENSOR-03	1-10V Microwave Sensor suitable for ceiling heights from 3 to 15 m	590mm	0.5kg

Product detail

Accessory



Other accessories and fixing components

Serial number	Description	Weight (kg)
01	1450mm Aluminum blind cover	0.875
02	M6 screw Surface Mounted Kits Suspension Kits	0.014
04	M10 screw Surface Mounted Kits Suspension Kits	0.014
05	2M Steel cable suspesion kits	0.03
06	4M Steel cable suspesion kits	0.05
07	5M Steel cable suspesion kits	0.08
08	2M Chain suspension kits	0.193
09	Chain suspension kits without chain	0.06